

PFB604W

14" Housing Wall Mount Bracket



Features

- Material: Aluminum
- Wall Mount Bracket
- Hidden Line Design
- Neat & Integrated Design

Specifications

Model	PFB604W
General	
Material	Aluminum
Dimension (W x H x D)	100mm x 146mm x 264mm
Pipe Thread	N/A
Operating Temperature	-40°C~65°C
Humidity	0~90% RH
Load Bearing	4.0Kg
Weight	0.56Kg
Color	White
Applicable Model	Please see "Accessory Selection"

PFB604W

Dimensions (mm)

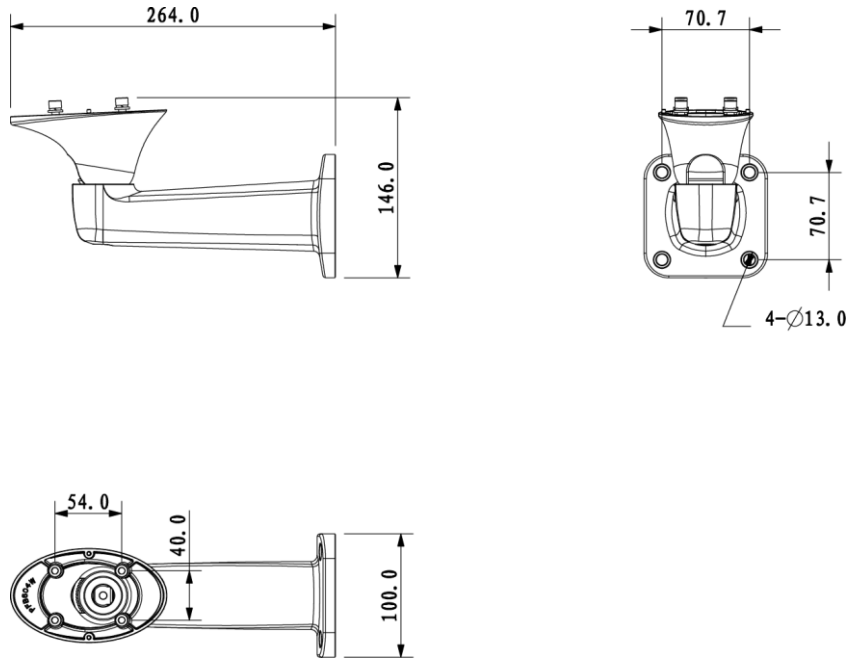

Application

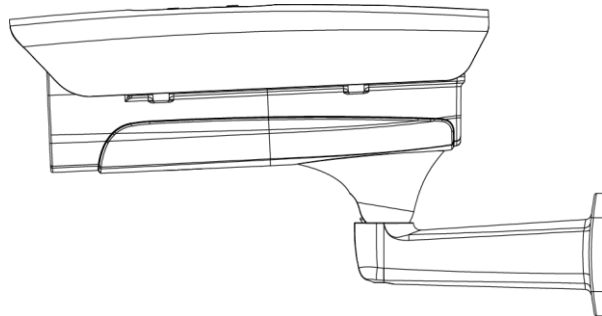

Dahua Technology Co., Ltd.

1199BinAn Road, Binjiang District, Hangzhou, China

Tel: +86-571-87688883

Fax: +86-571-87688815

Email: overseas@dahuatech.com

www.dahuasecurity.com

*Design and specifications are subject to change without notice.

© 2013Dahua Technology Co., Ltd.